

**CARBURO DI
TUNGSTENO
TUNGSTEN
CARBIDE**

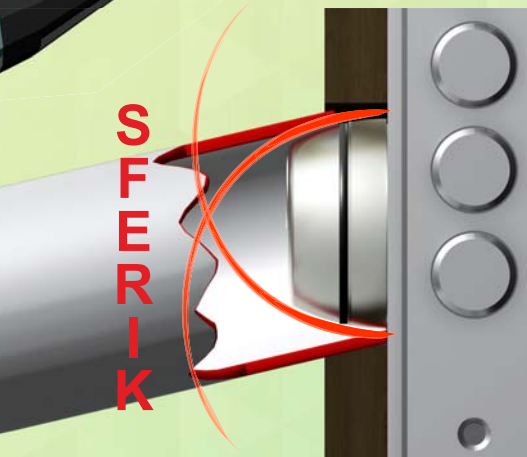
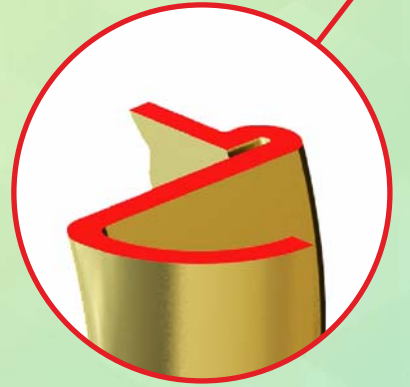

MONOLITO KRIPTON BKS200..

COLORI DISPONIBILI / COLOURS AVAILABLE

- Cromo lucido / Bright Chrome C
- Cromo satinato / Satin Chrome T
- Bronzo / Bronze B
- PVD Ottone / PVD Brass 2

ROTORI DISPONIBILI / ROTORS AVAILABLE

- | | | | | |
|----------|-------|------------|---------|--------|
| S1 | D1 | C1 | X1 | K1 |
| | | | | |
| Standard | x Dom | x Cisa TSP | Chiavi✕ | x Ikon |



11mm

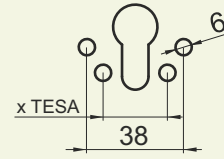

BKS200-18..

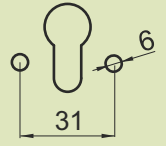

BKS300-18..

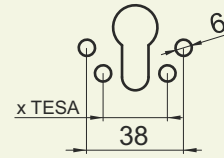
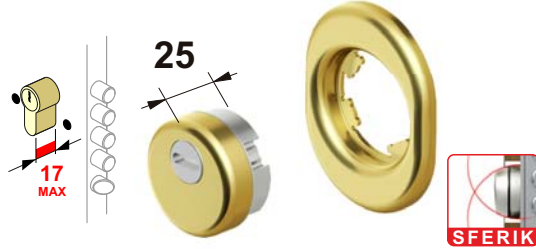

BKS200-25..

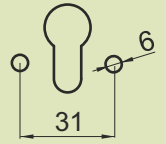

BKS300-25..



5mm

PANNELLI SOTTILI / THIN PANELS

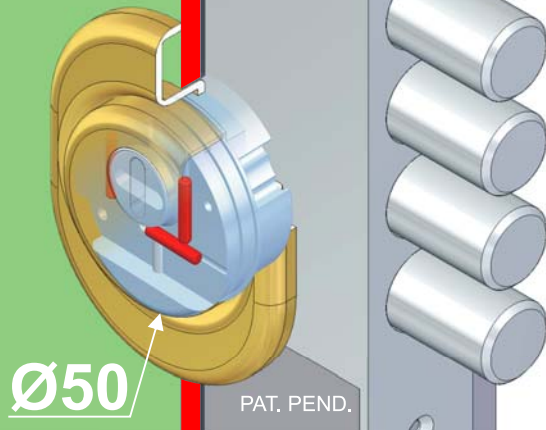

- x CERUTTI
- x CISA
- x FIAM
- x MOTTURA
- x SECUREMME
- x TESA

- x ATRA

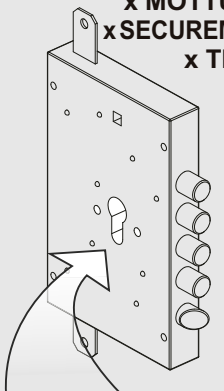

BKS201-18..

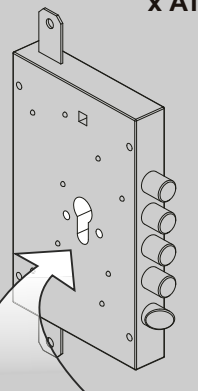

BKS301-18..

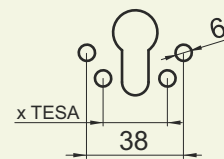

BKS201-25..

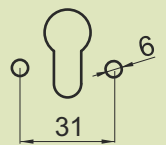

BKS301-25..